

SPEEDTRACKER mach4

SPEED MATTERS
ENJOY ACCURACY



QUICK REFERENCE GUIDE

for **COMPETITIVE
MARKSMANSHIP**



VERSION: V2.4
DATE: April 2023

SPEEDTRACKER mach4

TABLE OF CONTENTS

- | | | | |
|---|--------------------|---|----------------|
| 1 | INTRODUCTION | 6 | ACCESSORIES |
| 2 | TECHNICAL FEATURES | 7 | NOTICES |
| 3 | FIRST SET UP | 8 | FAQ |
| 4 | APPLICATION | 9 | MORE RESOURCES |
| 5 | POSITIONING | | |



1 INTRODUCTION

SPEEDTRACKER mach4

IS THE MOST ADVANCED RADAR
FOR BULLET SPEED DETECTION ON THE MARKET



- Capturing speeds up to 1200 m/s – 4000 fps.
- Patented technology with highly optimized beam shaping and foam filter.
- Fits in the palm of your hand and is mounted directly onto your firearm.
- Engineered and developed by a team of European engineers from Germany and Czech Republic.

GUARANTEED
12 MONTH WARRANTY

MANUFACTURED
100% IN EUROPE

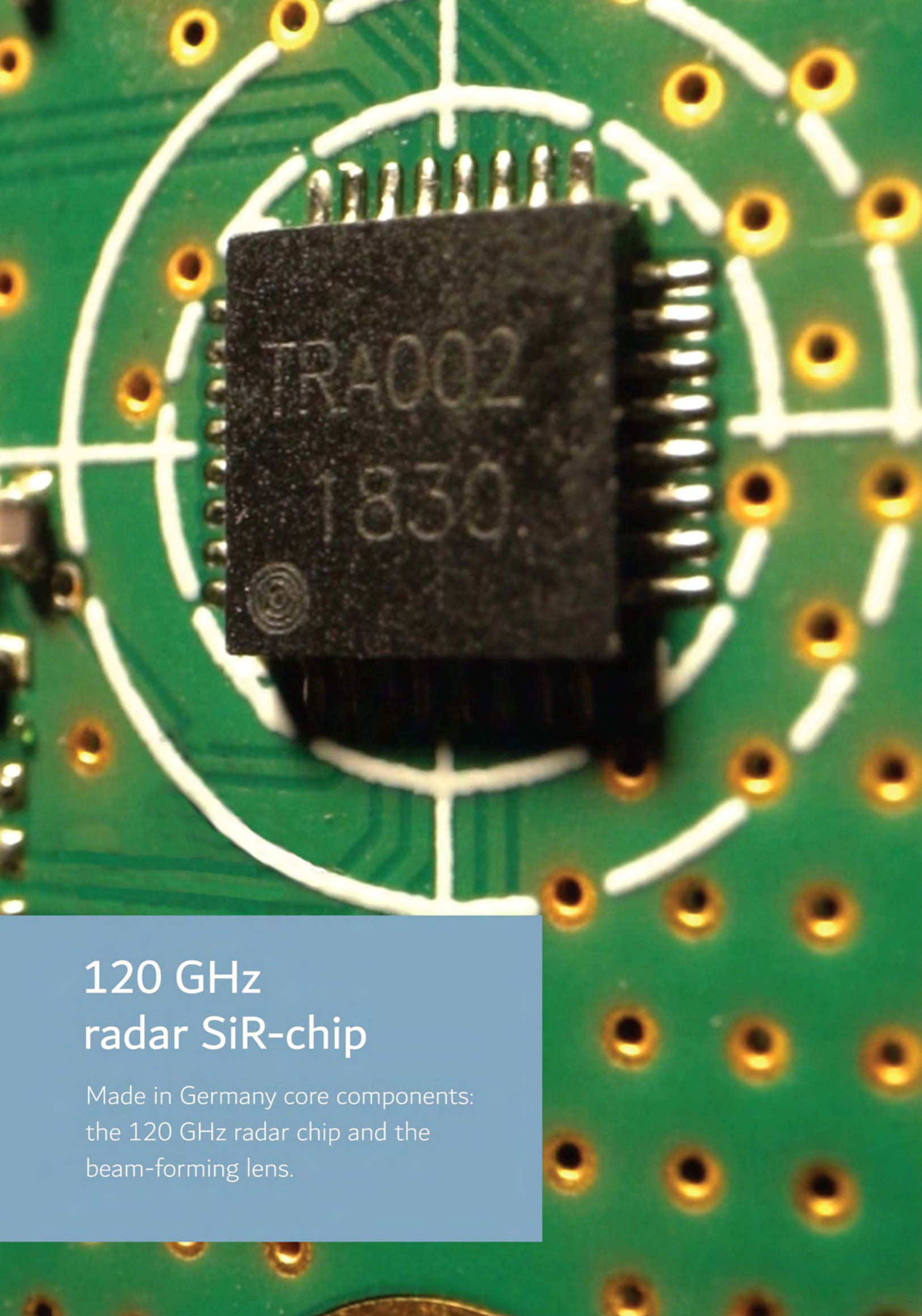

120 GHz radar SiR-chip

Made in Germany core components:
the 120 GHz radar chip and the
beam-forming lens.

2 TECHNICAL FEATURES

- Biggest radar cross section of bullets and pellets on the market.
- Enjoy extremely high accuracy with multiple detections in the 1st meter.
- Detecting the bullet up to 2 000 times.

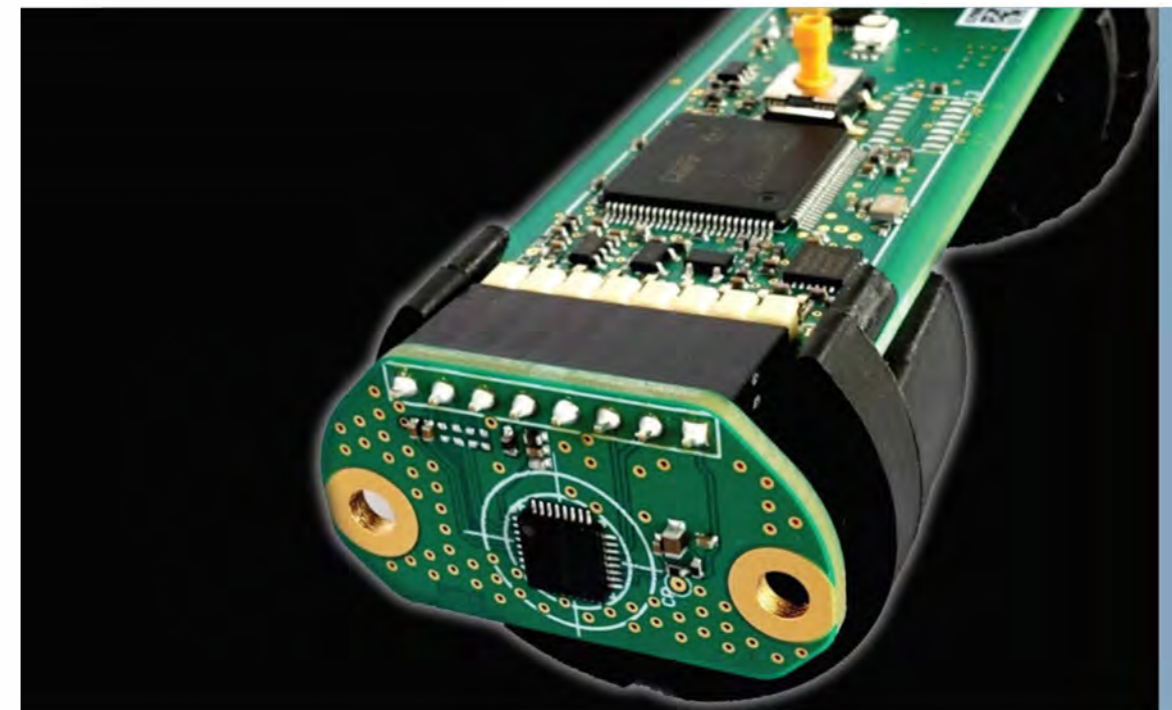

- Not affected by wind and air pressure.
- 20 to 2 000+ measuring points.



BLUETOOTH pairing to iPhone & Android.

3 FIRST SETUP

Press for switch on / off the switch for 1 second.



GREEN Start Bluetooth connection.
Open the APP.

ORANGE Bluetooth pairing.



Start the APP, go to the HOME screen and press CONNECT.

The first time, a window will pop up asking for pairing permission.

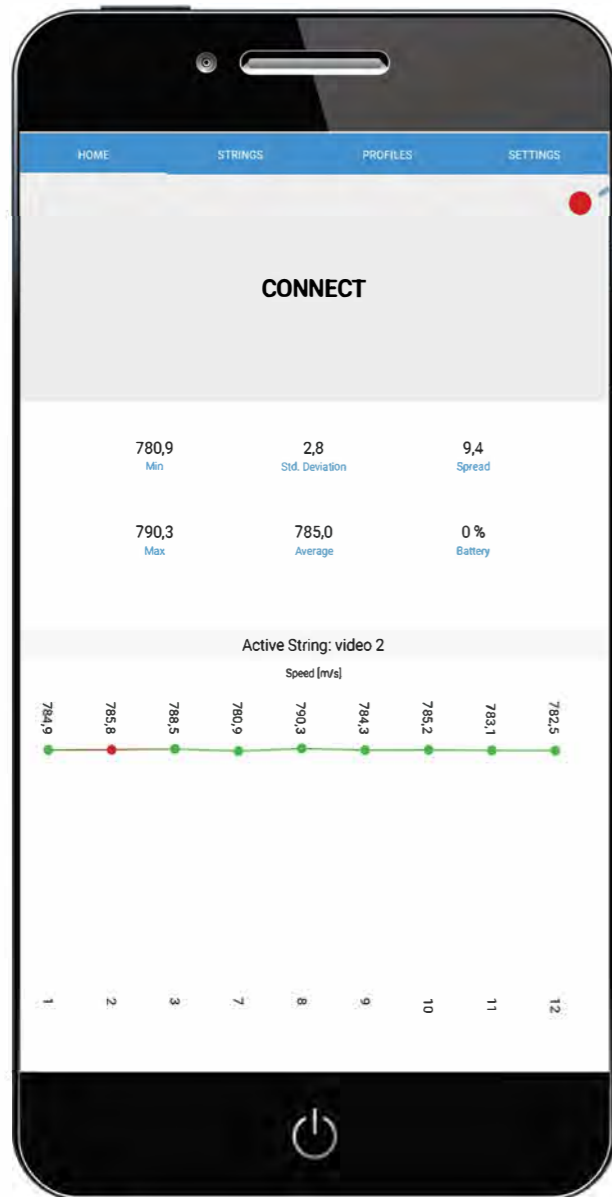

Red dot in the upper right corner indicates **not connected**.

During pairing, the *SPEEDTRACKER* LED lights up **orange**.

If the dot in the right upper corner has changed to **green**, the *SPEEDTRACKER* is **connected with your phone**.

The LED of the *SPEEDTRACKER* now also lights up green.

Ready for shooting.

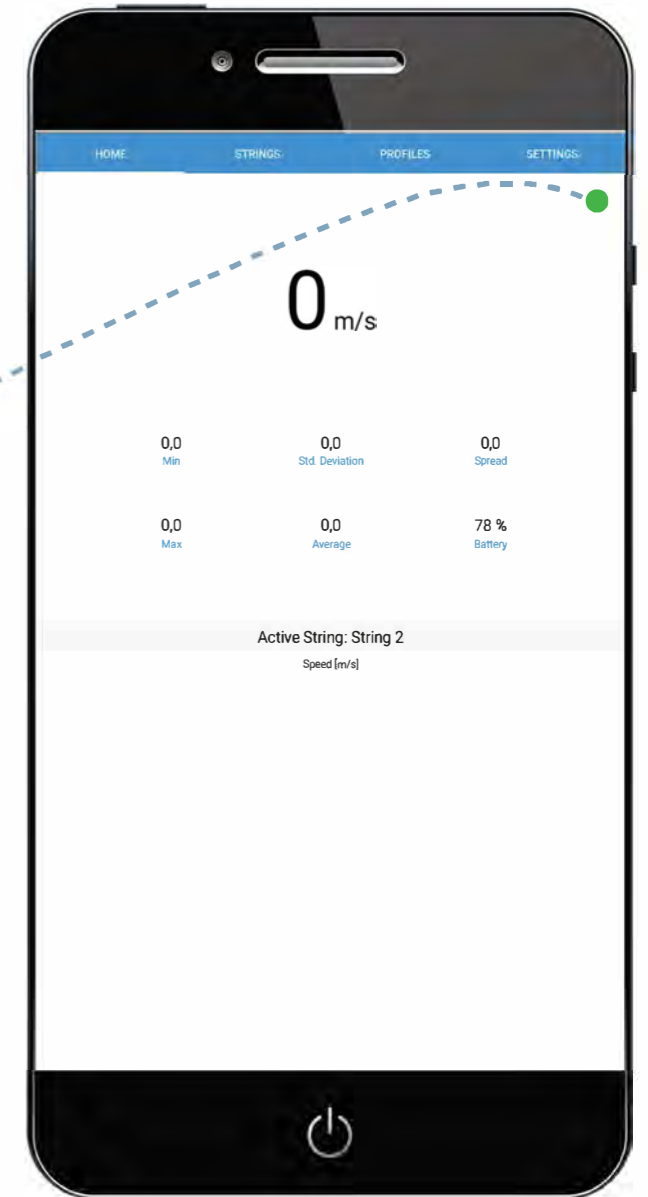

4 APPLICATION



- The application is very complex.
- All data is stored on your phone, can be exported and used in external programs.
- You can create a backup and restore it again.
- You can create profiles.
- Store shot data such as rifle, barrel length, ammunition data, etc.
- Your location and weather data will be saved.
- Settings are reduced to the minimum.
- Everything is largely automated.



DOWNLOAD THE APP
SPEEDTRACKER MACH 4



4.1 SETTINGS



SELF-EXPLANATORY

All units can be set to metric or imperial.

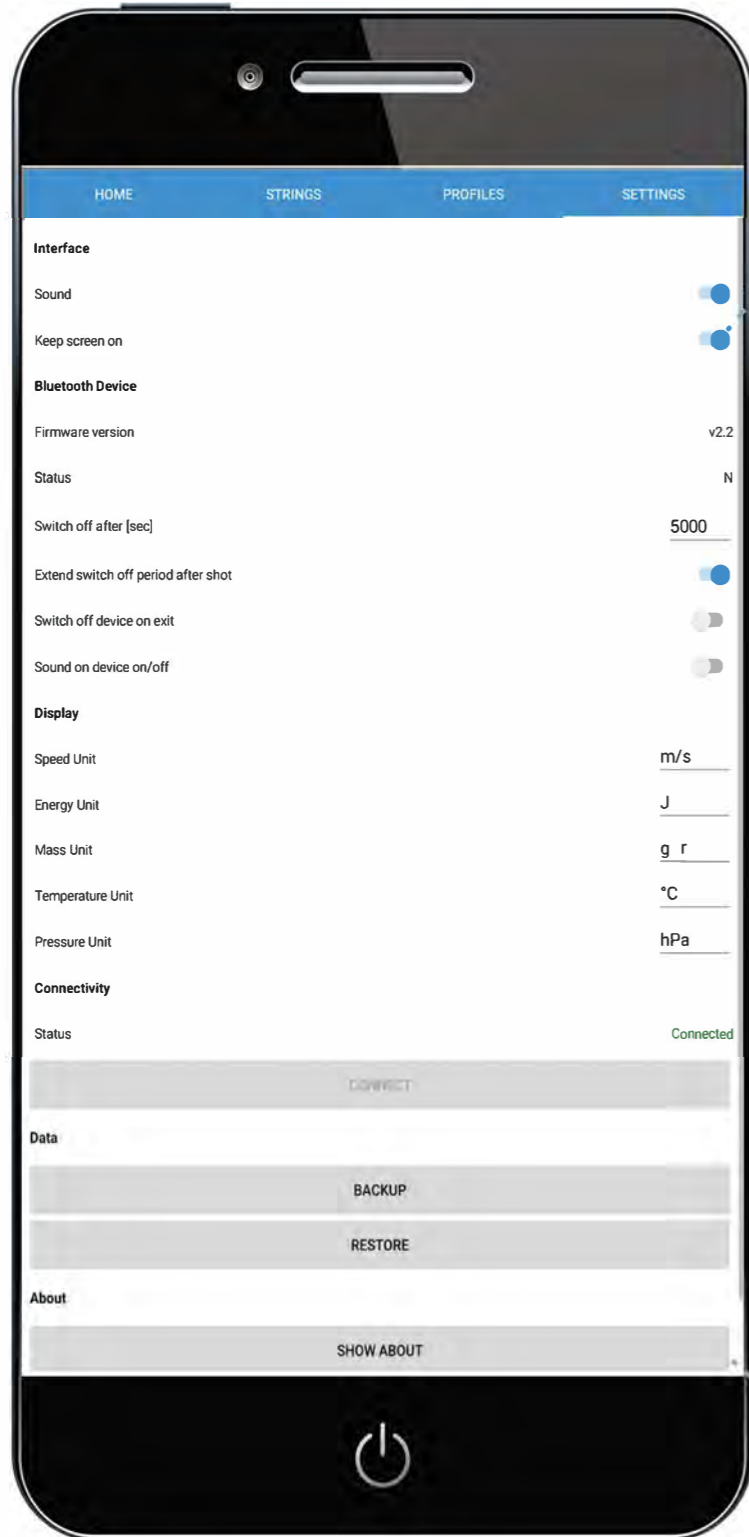

SOUND

The language set in the phone will be used.

SHOW ABOUT

Press the button the APP version will be displayed.

4.2 PROFILES

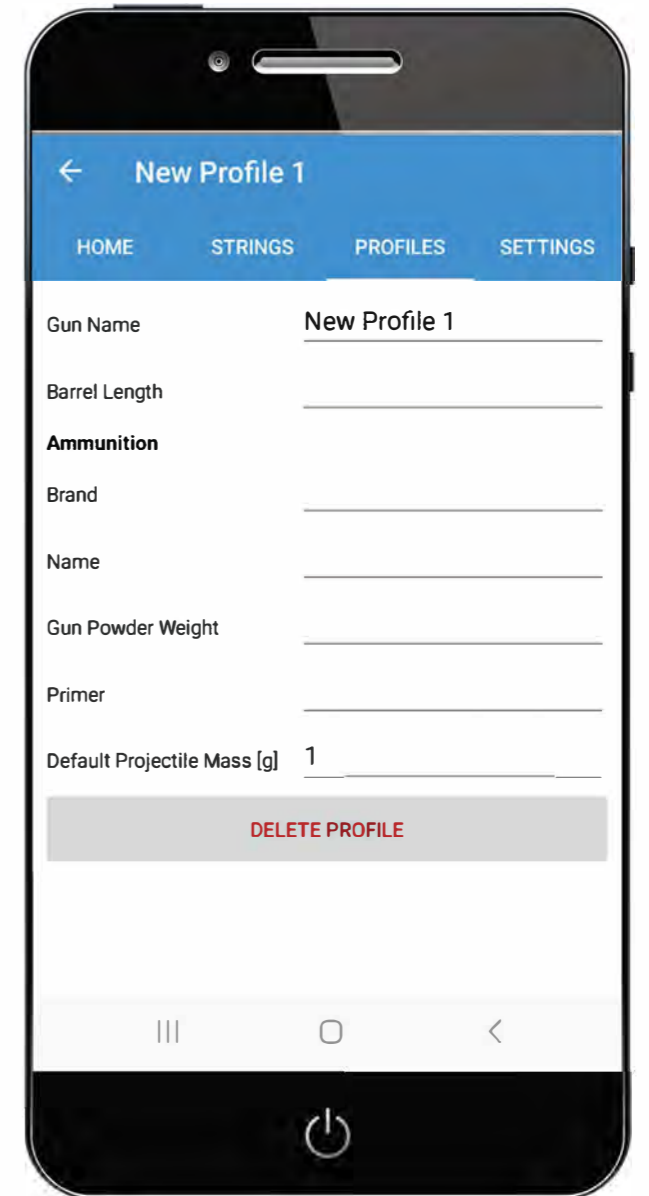
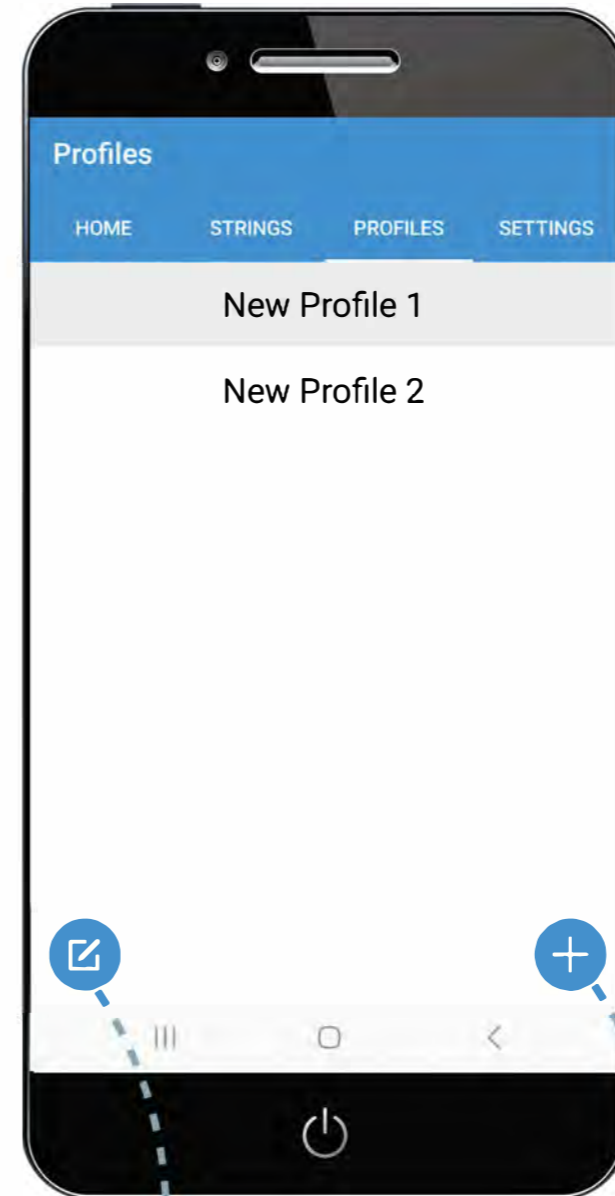

EDIT THE PROFILE

CREATE NEW PROFILE

4.3 HOME



SELF-EXPLANATORY

THE NUMBER OF DETECTIONS

GREEN	very good	>100
ORANGE	good enough	50-100
RED EFFICIENT	improve position	<50

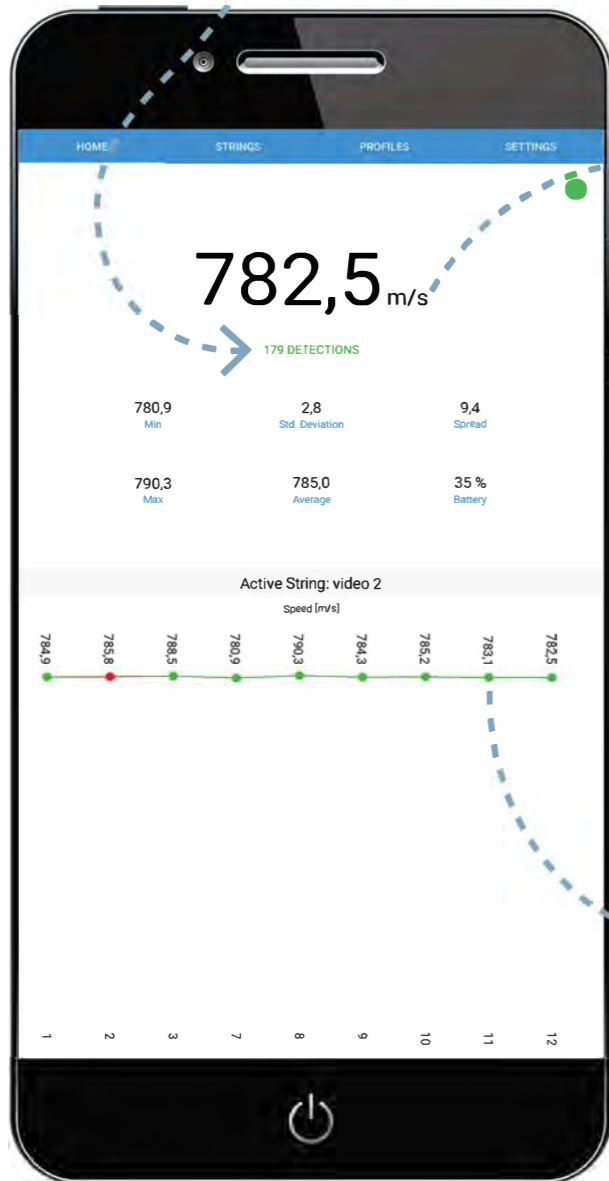

Speed values according to the setting in **SETTINGS** (metric / imperial).

The color scale can also be found below in the graph of all shots.

4.4 STRINGS



SELF-EXPLANATORY

Open with a finger tip.

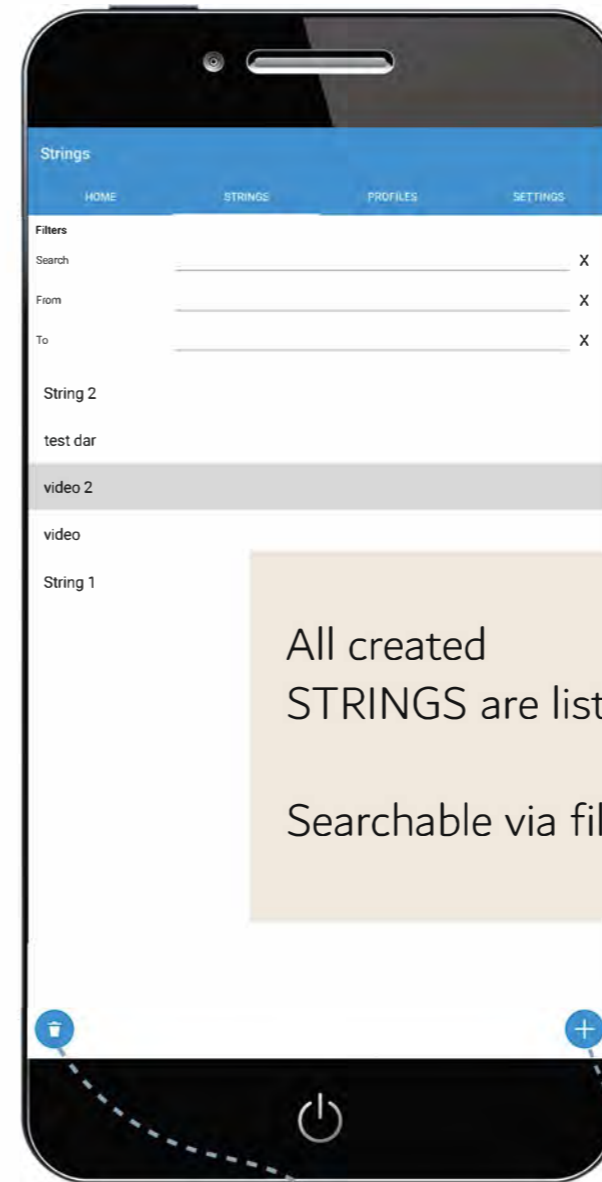

All created STRINGS are listed. Searchable via filter.

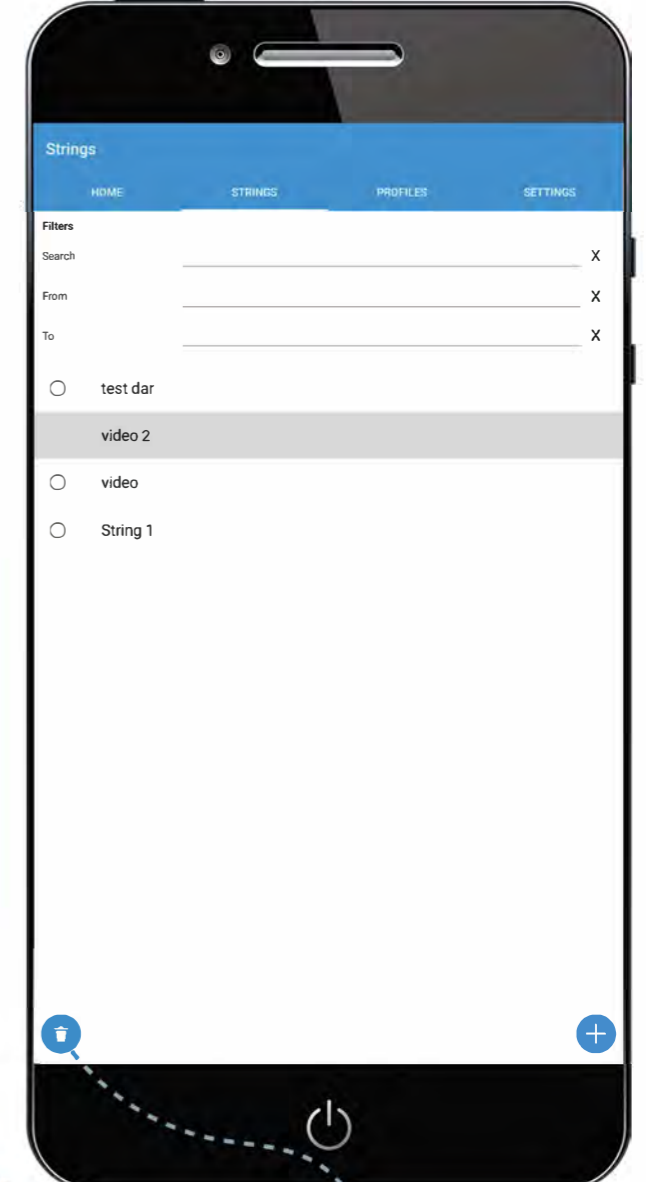

DELETE THE STRING

CREATE NEW STRING

MULTIPLE DELETE

4.4 STRINGS

SELF-EXPLANATORY

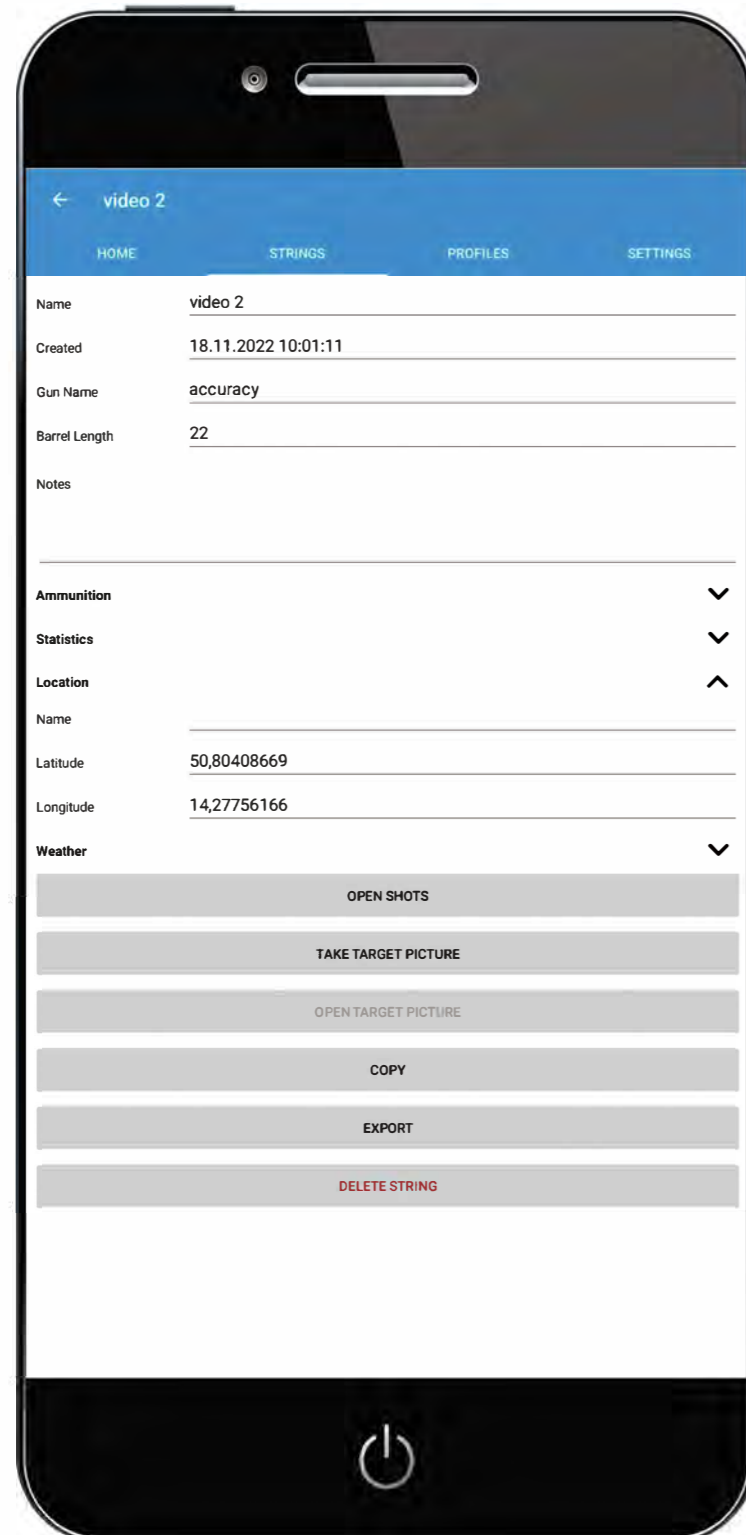

If you copy a string, the current data (rifle, barrel length, ammo, etc.) but without the shot data are duplicated.

EXPANDED DATA

Ammunition
Statistics
Location
Weather

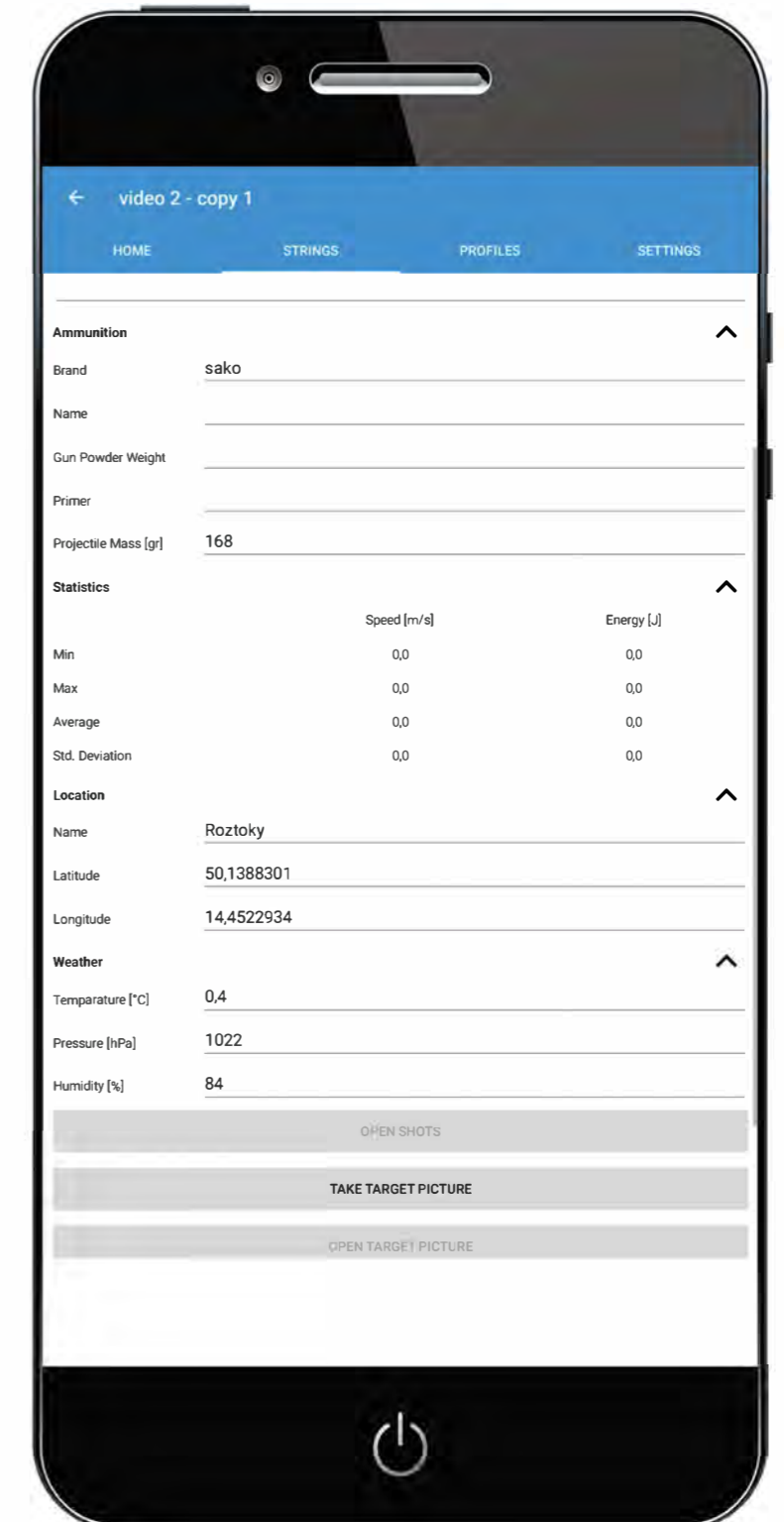

4.4 STRINGS

SHOT LIST

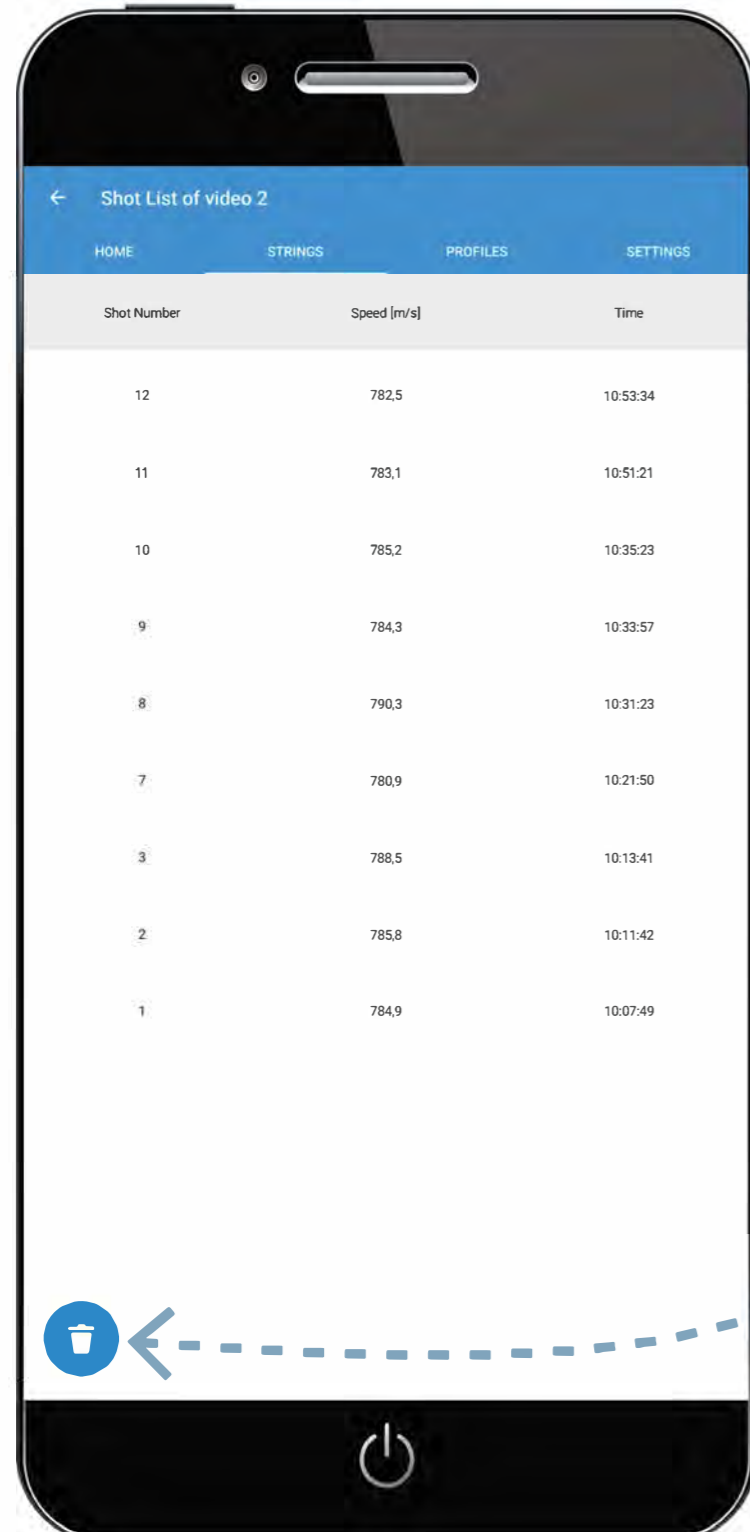

Open single shot by finger tip.

If you press the **delete button**, another window opens for selecting the shots to be deleted.

The graph shows every single detection of the shot. The average speed is determined from these detections.

With the finger slider, you can manually filter out unwanted data that can be caused by the angular error at the beginning or end.

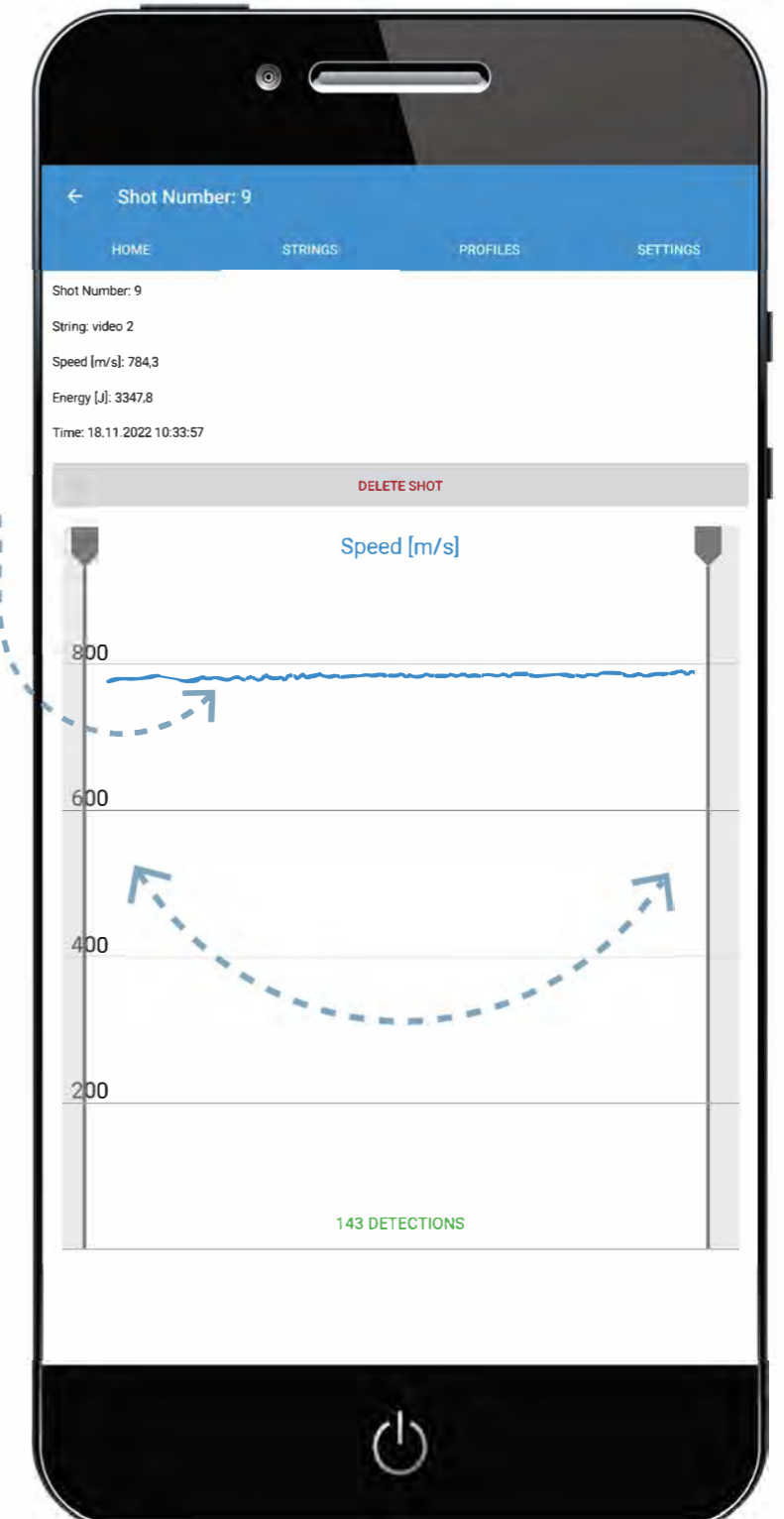

5 POSITIONING

SPEEDTRACKER mach4



- Explosive ammunition creates a muzzle cloud from hot gases and metallic abrasion. This cloud of plasma and metal splinters is electrically conductive. It can interfere with the radar waves and wipe out the signal.
- We have tested several different muzzle brakes. Each one has its own sweet-spot.
- Muzzle brakes with a guided gas jet such as star or spiral shape allow the radar signals to pass through very well.

BEST PRACTISE

- Find the right position on your gun by testing.**
- You can improve this slightly by looking at the number of detections per shot. **More is better.**

- Mount your *SPEEDTRACKER* parallel to the barrel, lateral distance max. 15 cm / 6" and max. 60 cm / 24" behind the muzzle brake. These distances can be increased with the parabolic adapter.
- Due to the large number of combinations of weapons, ammunition and possible positions, we cannot give any general recommendations. Try out different positions and optimize this with the help of the number of detections.

ParabolicAdapter

- Usually we measure in the first meter. In the case of problematic muzzle clouds, however, if the signal is blocked with the adapter we can see up to 3m - i.e. behind the muzzle clouds.
- Due to its parabolic shape and larger diameter, the parabolic adapter carries more signal to the receiver.
- The diameter is chosen to be smaller than the size of the *SPEEDTRACKER* + click adapter. So no assembly problems.



BEST PRACTISE
FIND THE RIGHT POSITION ON
YOUR GUN BY TESTING.

6 ACCESSORIES

SPEEDTRACKER mach4

SwingAdapter

For stepless position adjustment.

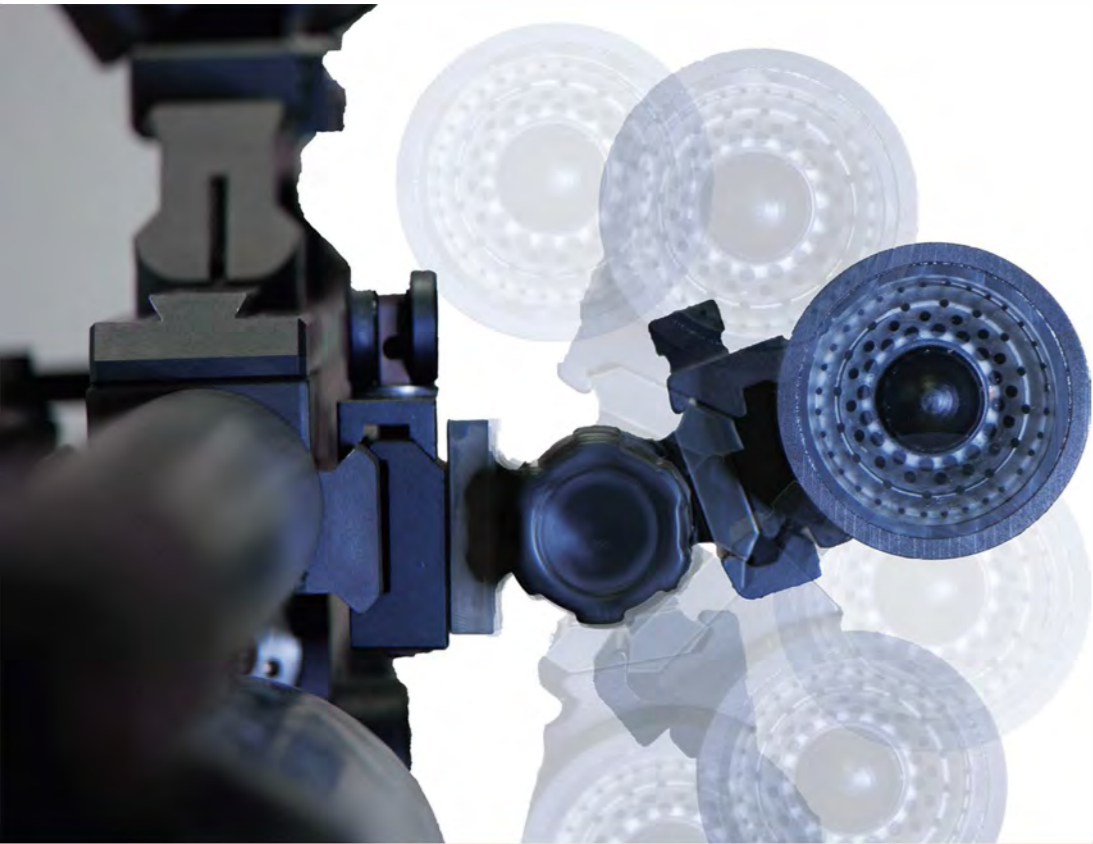

ParabolicAdapter

When using the silencer, we recommend using the ParabolicAdapter, which increases the range from 1 to approx. 3 m.

The same applies to difficult conditions with strong muzzle flashes or bulk ammunition.



BEST PRACTISE
FIND THE RIGHT POSITION ON
YOUR GUN BY TESTING.

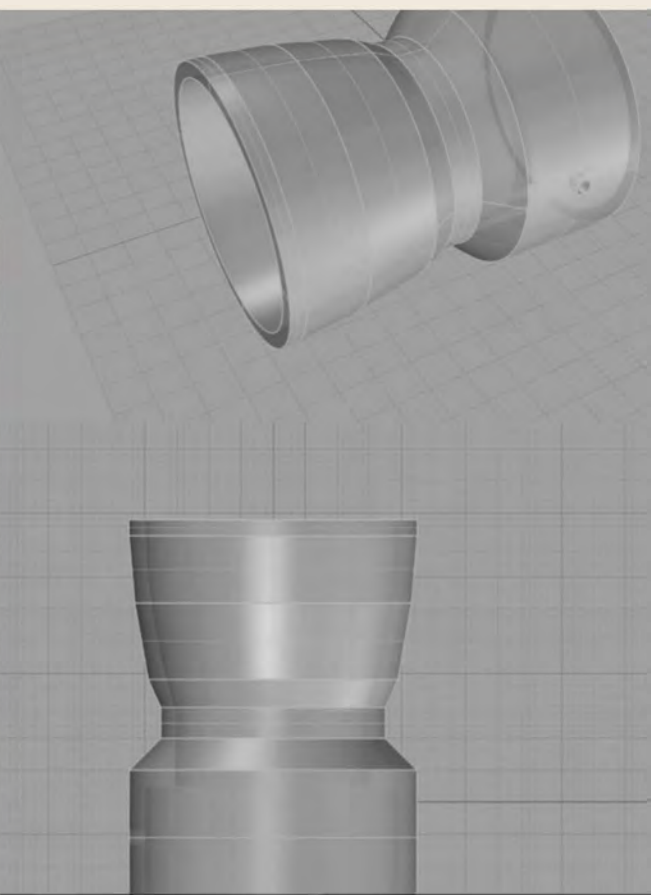

7 NOTICES

SPEEDTRACKER mach4

NOTICE FOR USA

This device complies with Part 15 of the FCC Rules.

Operation is subject to the following two conditions:

- (1) this device may not cause harmful interference, and
- (2) this device must accept any interference received, including interference that may cause undesired operation.

Unauthorized modifications may void the authority granted under Federal communications Commission Rules permitting the operation of this device.

This equipment has been tested and found to comply with the limits for a Class A digital device, pursuant to Part 15 of the FCC Rules. These limits are designed to provide reasonable protection against harmful interference when the equipment is operated in a commercial environment.

This equipment generates, uses, and can radiate radio frequency energy and, if not installed and used in accordance with the instruction manual, may cause harmful interference to radio communications. Operation of this equipment in a residential area is likely to cause harmful interference in which case the user will be required to correct the interference at his own expense.



NOTICE FOR CANADA

Operation is subject to the following two conditions:

- (1) this device may not cause interference, and
- (2) this device must accept any interference, including interference that may cause undesired operation of the device.

Usually this is followed by the following RSS caution: Any changes or modifications not expressly approved by the party responsible for compliance could void the user's authority to operate this equipment.

Le présent appareil est conforme aux CNR d'Industrie Canada applicables aux appareils radio exempts de licence.

L'exploitation est autorisée aux deux conditions suivantes:

- (1) l'appareil ne doit pas produire de brouillage, et
- (2) l'utilisateur de l'appareil doit accepter tout brouillage radioélectrique subi, même si le brouillage est susceptible d'en compromettre le fonctionnement.

The device is CE and FCC certified.



8 FAQ

SPEEDTRACKER mach4

AUTOMATICALLY SAVED DATA STRINGS

SPEEDTRACKER MACH4 APP has an integrated databank and is saved on your phone.

DETECTIONS ARE DISPLAYED WITHOUT SHOOTING

The battery voltage has dropped too far - recharge the *SPEEDTRACKER* or other electromagnetic fields affect the radar.

FILE FORMAT

Exported data have the file format "string name.csv".

PARTIAL DETECTION ONLY

This is a positional issue caused by a radar shadow or cloud of fire. A change in position is required.

Good control is seen in the number of detections. To see below the speed in the HOME screen. More detections - better position. Another option is to use the ParabolicAdapter or mounting rails for easy position improvement.

NO OR PARTIAL DETECTION

Turn off ALL Bluetooth connections except the *SPEEDTRACKER* connection.

Check if other electrical or electronic devices in the immediate vicinity are interfering with the radar signal.

BATTERY

3 hours of continuous use. 2 hours charging.

BLUETOOTH CONNECTION ISSUE

If you have paired your BLUETOOTH device with the *SPEEDTRACKER* and it is not working.

It may be in the background and it is important to note that the foreground APP has the priority.

In principle, several BLUETOOTH connections are possible with one device. However, usually only one is active. If there are two tools (*SPEEDTRACKER* and another) connected to your device through BLUETOOTH, a conflict is identified.

Make the *SPEEDTRACKER* the priority APP.



9 MORE RESOURCES

ALIGNMENT

WHY IS IT SO IMPORTANT

The velocity of the projectile is determined using the Doppler frequency. With the frequency shift we can measure the speed of the moving object. However, the measurement is dependent on the angle.

We calculate this using the cosine gamma.

The difference of 0 degrees (ideal orientation) and only **10 degrees** radar line to the line of fire the measurement error is already **1.5 %**.

But 1.5 % at 900 m/s -- 2952 fps = 13.5 m/s -- 44 fps !!!

That's why we designed the *SPEEDTRACKER* to get as close to the line of fire as possible. Due to the assembly on the rifle, you always have the same position and the data can always be compared easily.

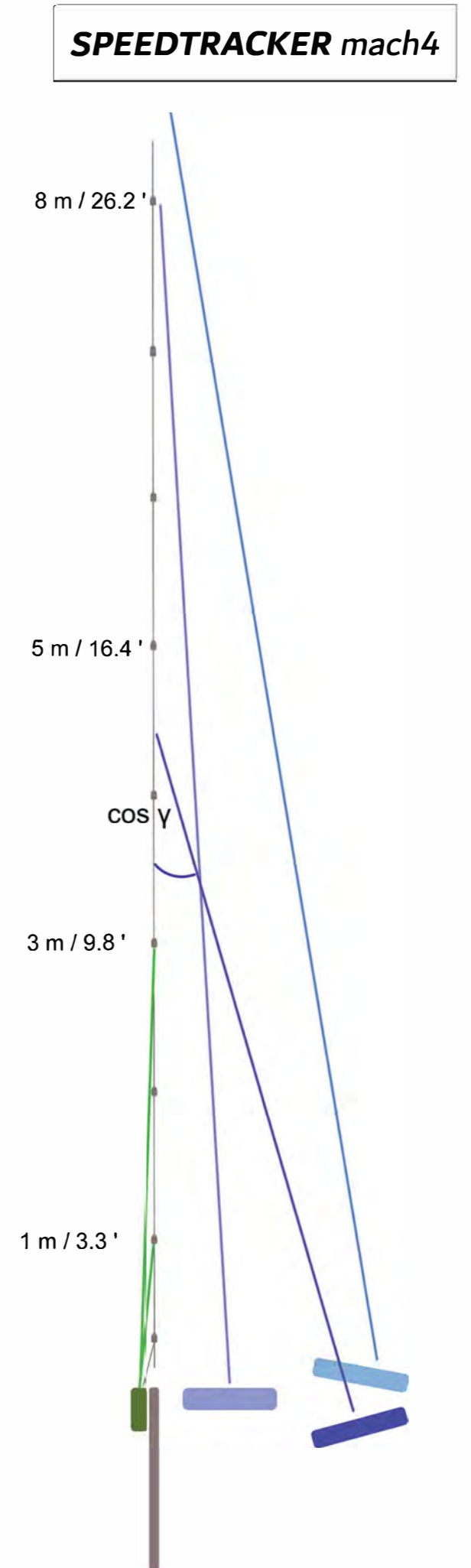
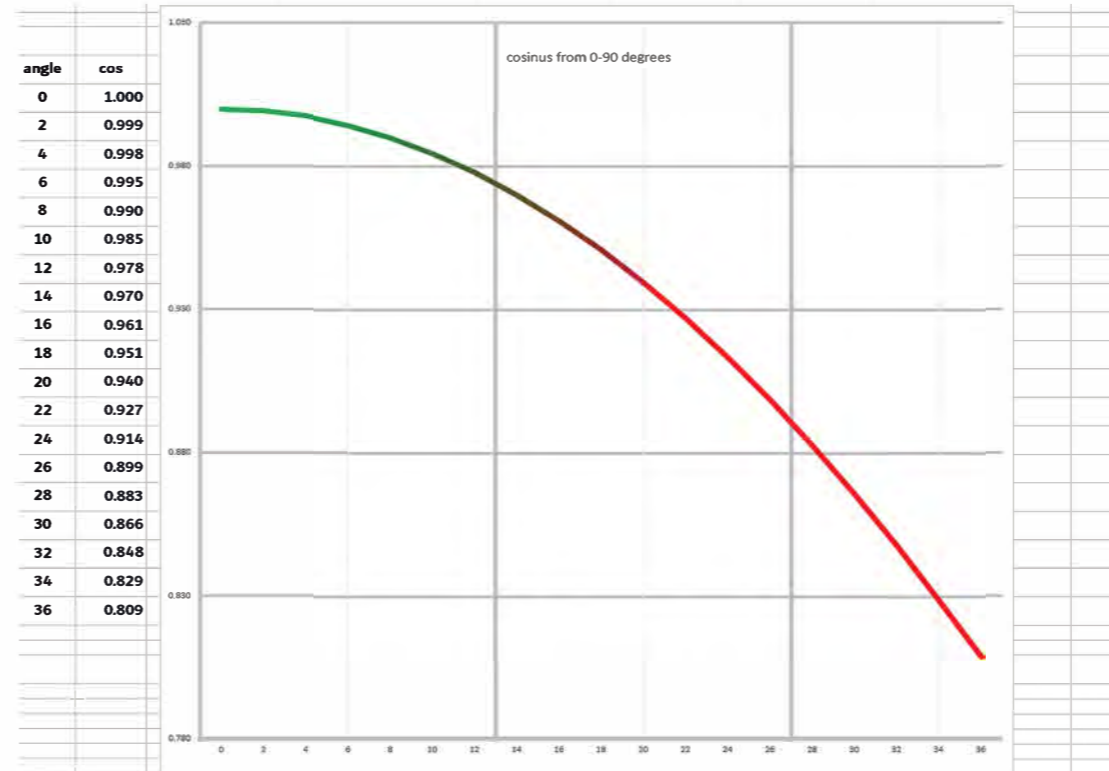

SPEEDTRACKER *mach4*

SPEED MATTERS
ENJOY ACCURACY



QUESTIONS? CONTACT US



www.speedtracker.tech



welcome@speedtracker.tech



support@speedtracker.tech



Sold By:
**SEKR-TEK Speed Tracking
Systems**
Andalucia, Spain



VERSION: V2.4
DATE: April 2023